

Il prezzo si intende cadauno IVA esclusa - S.E. & C. e SALVO ESAURIMENTO SCORTE - Marchi e modelli riportati sono di proprietà delle rispettive case produttrici - Alcune foto sono puramente indicative. L'importo delle tasse SIAE, COBAT e RAEE per gli articoli che ne sono soggetti, ove non specificato, verrà addebitato ed indicato separatamente in fattura. Per alcune referenze potrebbero essere consegnati alternativamente marchi diversi in base alle disponibilità del momento. Tutti i prezzi possono cambiare senza preavviso.

Tastiere controllo accessi

	630001 - IP67 - Display LED 3 colori - 1000 utenti - Accesso tramite TAG		630002 - Soft touch - IP67 - Display LED 3 colori - 1000 utenti - Accesso tramite TAG
	630003 - Anti-vandalo - IP67 - 1000 utenti - Accesso tramite TAG / App	Codice	
		630001	
		630002	
		630003	

Kit allarme wireless 868 MHz

	500807 4G - Wi-Fi - TCP/IP - Sirena integrata -	Codice	
		500807	
	500030 - Contatto magnetico wireless		500031 - Sensore di movimento wireless
	500032 - Sensore di movimento wireless - Pet immune fino 20Kg - Antimanomissione		500034 - Sirena da esterno wireless
	500035 - Tastiera RFID wireless	Codice	
		500030	
		500031	
		500032	
		500034	
	500038 - Sensore movimento tenda wireless	Codice	
		500035	
		500038	

Lampade da giardino in plastica per esterni

	3241870		3241850
	3241910		3241890
		Codice colore	
		3241880	Nero
		3241920	Antique
	3241850		
	3241890		
	3241870		
	3241910		
	3242240		
	3242250		

Batterie GP

	11A		12V
	27A		23A
	3B		A76
	CR2		
	Blister 2 pcs		
	Codice		
	GP103136	11A/MN11 6V	
	GP103021	A27/MN27 12V	
	GP103020	A23/V23GA 12V	
	GP5513	LR1/910A	
	GP102002	A76/LR44	
	GP3703	CR2 3V	
	GP103216	CR2025 (10pcs)	

Mini Radio FM portatile

	AM / FM - Dimensioni: 82 x 50 x 18mm	Codice	
		SLE092	

Purificatori aria

	INN-554 - 25 m ² - filtro 3 in 1 - Wi-Fi - App di controllo	Codice	
		INN-555	
	INN-555 - 35 m ² - filtro 4 in 1 - Wi-Fi - App di controllo - Display cromatico	Codice	
		INN-554	

Torrette Elettriche

	8102N - 8102WH		8103N - 8103AL
	8504N - 8504FAL		850AL
	Codice		
	8102N	Nero 4 pos	
	8102WH	Bianco 4 pos	
	8103N	Nero 6 pos	
	8103AL	Alluminio 6 pos	
	8504N	Nero 8 pos	
	8504FAL	Alluminio 8 pos	
	850AL	Alluminio 10 pos	

Fascette in nylon (PA6)

Protezione UV	
Prezzo a confezione	
Codice	Conf
7100210	2,5 x 100 mm - bianca 100 pcs
7100220	2,5 x 100 mm - nera 100 pcs
7100260	2,5 x 200 mm - nera 100 pcs
7100290	3,6 x 200 mm - bianca 100 pcs
7100300	3,6 x 200 mm - nera 100 pcs
7100310	3,6 x 300 mm - bianca 100 pcs
7100340	4,6 x 200 mm - nera 100 pcs
7100380	4,6 x 300 mm - nera 50 pcs
7100350	4,8 x 250 mm - bianca 100 pcs
7100360	4,8 x 250 mm - nera 100 pcs

Dispositivi smart guida DIN

	723011 - Differenziale monofase configurabile	Controllo remoto con app Tuya	
	723010 - Relè 1 contatto NO - Timer o countdown configurabile		
	Codice		
	723011		
	723010		

Cavi USB - Ethernet

consente una connessione Internet stabile e cablata ai dispositivi USB senza una propria porta di rete

	70697 - USB-C		70497 - USB-A
	Codice		
	70697		
	70497		

PREMIO FEDELTA : LAMPADINE LED IN OMAGGIO

Ad ogni ordine che inserirete sul sito Sidium di almeno 399 euro potrete ricevere 10 pz di lampadine a goccia 9W e/o 10 pz di lampadine mini sfera 7W in OMAGGIO.

Come ordinare gli omaggi: inserite al vs ordine anche 10 pz cod. 97536 e/o 10pz cod. 92595, nella schermata del carrello in alto a dx dovrete cliccare su: **HAI UN CODICE SCONTO?** nella finestra che si aprirà scrivete uno o entrambi i codici sconto **M9Y1T7LM x 97536 e TKQ98EDQ x 92595** Vi apparirà in colore arancione la scritta **OMAGGIO LAMPADINE 97536 e/o 92595** con il relativo sconto.

In questo modo potrete ricevere AD OGNI ORDINE di almeno 399 euro anche 10+10 lampadine VITO IN OMAGGIO

Batterie Litio DURACELL®



Codice		Blister
49575	CR2032	2 pcs
23733	CR1220	1 pcs
49560	CR1620	1 pcs
49561	CR2016	2 pcs
49562	CR2025	2 pcs
49576	CR2430	1 pcs
49574	CR2450	1 pcs
49559	CR1616	1 pcs
43326	CR1632	1 pcs
42096	CR 123A	1 pcs

Batterie Alkaline Varta LONGLIFE POWER



Codice		Blister
46817	AAA	4 pz
46815	AA	4 pz
46824	C	2 pz
46825	D	2 pz
46826	9V	1 pz

Batterie Ricaricabili GP Ni-Mh

GP201212 - 4 x Stilo AA 2100 mAh

GP201215 - 4 x Ministilo AAA 950 mAh

GP202230 4 x Stilo AA 2000 mAh + caricabatterie

GP202234 4 x Ministilo AAA 850 mAh + caricabatterie

Batterie Ricaricabili Ni-MH



HZ020-021-033-023 43473 - 43471 - 48077

Codice		
48094	AAA - 800 mAh	blister 2 pz
HZ020	AAA - 900 mAh	blister 4 pz
43471	AAA - 1000 mAh	blister 4 pz
HZ021	AAA - 1300 mAh	blister 4 pz
48077	AA - 2100 mAh	blister 2 pz
43473	AA - 2600 mAh	blister 4 pz
HZ023	AA - 3000 mAh	blister 4 pz

Batterie Alkaline DURACELL®



62297 42005 49003



42004 42110

Codice	Tensione	Blister
62297	MN21 12V	2 pcs
42005	MN11 6V	1 pcs
49003	LR1 / N 1,5V	2 pcs
42004	MN27 12V	1 pcs
42110	LR44 1,5V	2 pcs

Batterie Alkaline VARTA Max Power



Confezione Blister 4 pz

Codice	
46837	AAA
46836	AA

Batterie Alkaline Varta PRO



Confezione Scatola 10 pz
Min Ordinabile 10 pz

Codice	
45142	AA
45143	AAA
45148	9V

Batterie Zinco Carbone Varta



Codice	Blister
45182	AAA 4 pz
42335	AA 4 pz
42338	9V 1 pz

Batterie Zinco-Aria Varta



Blister 6 pz

Codice	
43447	HA010 - 75 mAh
43448	HA013 - 265 mAh
43449	HA312 - 145 mAh
43450	HA675 - 40 mAh

Batterie Alkaline DURACELL® Plus 100



Codice	
49511	LR03/AAA - Blister 4 pcs
49514	LR06/AA - Blister 4 pcs
49512	LR14/C - Blister 2 pcs
49513	LR20/D - Blister 2 pcs
48510	6LR61/9V - Blister 1 pcs
42112	LR61/AAAA - Blister 2 pcs

Batterie Alkaline DURACELL®



PROCELL

Codice 1 Confezione = 10 pcs

52704	AAA
52705	AA
52708	9V

Batterie Alkaline Varta ENERGY



Codice	Blister
42330	AAA 4 pz
42331	AA 4 pz
42332	C 2 pz
42333	D 2 pz
42334	9V 1 pz

Batterie a bottone ossido d'argento 1,55 V



Confezione 1 pz / blister
acquisto minimo
10 blister e multipli
Prezzo a batteria

Codice	Ref.	Diametro	Altezza
48004	V357	11,6 mm	5,4 mm
48007	V364	6,8 mm	2,15 mm
48009	V371	9,5 mm	2,1 mm
48011	V377	6,8 mm	2,6 mm
48017	V390	11,6 mm	3,05 mm
48019	V392	7,9 mm	3,6 mm

Batterie Litio a bottone Varta



Codice	
48055	CR1616
48061	CR2430
48059	CR2032
48058	CR2025
48062	CR2450
48057	CR2016
46769	CR1/3N

!! Attenzione !! I prezzi del seguente volantino potrebbero cambiare più volte durante il periodo di validità.
Per essere aggiornati consultare il file Excel scaricabile dal sito Sidium.it nella sezione CATALOGHI DOWNLOAD

Batterie Varta



Batterie Litio 18650 Ricaricabili



Codice	
72495 - 97916	45086
97917 - 56561	91347
94774	
72495	14500/AA - polo piatto - 800 mAh
97916	18650 - polo piatto - 2500 mAh - 20 A max
97917	18650 - polo piatto - 2500 mAh - 30 A max
56561	18650 - polo piatto - 2500 mAh - 10 A max
45086	18650 - polo U - 2900 mAh - 10 A max
91347	18650 - polo U - 2250 mAh - 10 A max
94774	18650 - polo Z - 2500 mAh - 10 A max

Batterie Litio Cloruro 3,6 V



Codice	NON RICARICABILI
HZ040	1/2 AA - 1,2 Ah
HZ041	1/2 AA - 1,2 Ah a saldare
HZ043	AA - 2,4 Ah a saldare
23578	2/3 AA - 1,65 Ah
23501	AA 3,6V - 2400 mAh
LS14500	AA - 3.6V 2600mAh
LS14250A	1/2 AA a saldare 1200mAh

Batterie Ricaricabili al Piombo



16083	4V - 2 Ah	16072	6V - 12 Ah
16067	4V - 3 Ah	16073	12V - 1,3 Ah
16068	6V - 1,3 Ah	16074	12V - 2 Ah
16069	6V - 3,2 Ah	16075	12V - 2,3 Ah
16070	6V - 4,5 Ah	16082	12V - 4,5 Ah
16071	6V - 8 Ah	16077	12V - 7 Ah x Allarmi

Batterie Ricaricabili Ni-MH per Cordless



Codice	
HZ-T0199	AAA - 1,2 V - 600 mAh
HZ-T382	AAA - 2,4 V - 550 mAh

Caricabatterie

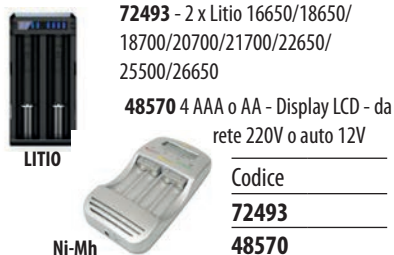

72493	2 x Litio 16650/18650/18700/20700/21700/22650/25500/26650
48570	4 AAA o AA - Display LCD - da rete 220V o auto 12V

Batterie Sub-C Ni-MH

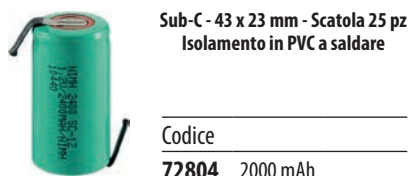

72804	Sub-C - 43 x 23 mm - Scatola 25 pz Isolamento in PVC a saldare
72804	2000 mAh

Batteria Ricaricabile al piombo FIAMM 12V - 7,2 Ah



20721	
--------------	--

Batterie ricaricabili NiMH 1,2 V a saldare



Codice	
55509	1 x AA - 2100 mAh
55652	3 x AA - 2100 mAh
55653	1 x AAA - 800 mAh
55581	3 x AAA - 800 mAh

Caricabatterie piombo



	2/6/12V - da 2,2Ah a 10Ah
SBCCH02	

Caricabatterie Li-Ion per veicoli elettrici - 2A



Codice	Tensione
109741	36 - 42V
109719	48 - 54,6V

Batterie Ricaricabili al piombo UL454

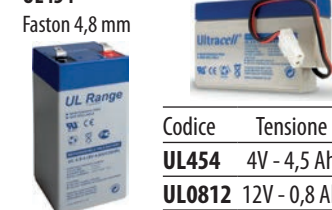

Codice	Tensione
UL454	4V - 4,5 Ah
UL0812	12V - 0,8 Ah

Tassa COBAT inclusa

44829	12V - 7,2 Ah
16076	12V - 9 Ah
16080	12V - 9Ah - CCLICA
16078	12V - 12 Ah
16081	12V - 12 Ah - CCLICA
16079	12V - 26 Ah

!! Attenzione !! I prezzi del seguente volantino potrebbero cambiare più volte durante il periodo di validità. Per essere aggiornati consultare il file Excel scaricabile dal sito Sidium.it nella sezione CATALOGHI DOWNLOAD

Cavo HDMI™ 1.4 High Speed con Ethernet 1,5 mt

Risoluzione max
2560 x 1600 - 60 Hz
3840 x 2160 - 30 Hz



Contatti placcati oro

Codice
51819

Cavo HDMI™ 2.0 High Speed con Ethernet 4K@60Hz - 18 Gbit/s

Supporta 3D @ 4K - Supporto HDR - Supporta ARC
Conforme HDCP 2.2 - CinemaScope - aspect ratio 21:9



Contatti placcati oro

Risoluzione max
3840 x 2160 - 60 Hz

Codice	Lunghezza
S44506	1 mt
S38516	1,5 mt
S38517	2,0 mt
S38518	3,0 mt
S44505	5,0 mt
S38520	7,5 mt
S38521	10 mt
S38522	15 mt

Cavo HDMI™ 2.1 High Speed con Ethernet 48 Gbit/s



Risoluzione max 7680 x 4320 - 60 Hz

Codice	Lunghezza
41083	1,5 mt
47575	3 mt
52766	5 mt

Cavo Scart - 1,5 mt



Codice
11702

Patch Cord U/UTP CAT 5e in CCA



Codice	Lunghezza
68337	0,5 mt
68342	1,0 mt
95557	1,5 mt
68357	2,0 mt
68367	3,0 mt
68377	5,0 mt
68347	10 mt

Patch Cord U/UTP CAT 6 in CCA



Codice	Lunghezza
S68434	0,5 mt
S68439	1,0 mt
S68454	2,0 mt
S68409	3,0 mt
S68419	5,0 mt
S68429	7,5 mt
S68444	10 mt

Cavo USB Spina A / Spina A - Nero



Codice
93593 1,8 mt

Cavo USB Spina A / Spina B



Codice
50953 Grigio 1,8 mt
68900 Nero 1,8 mt

Cavi USB-A / Micro USB



Codice Lunghezza
93918 1,0 mt - nero
93181 1,8 mt - nero

Cavi USB-A / USB-C



Codice Lunghezza
45735 1,0 mt - nero
45563 1,0 mt - bianco
59130 2,0 mt - bianco
44772 2,0 mt - nero

Cavi USB-A / Lightning



Codice Lunghezza
C1121 1,0 mt

Cavo USB-C / HDMI



4K 60 Hz, 1,80 m
Codice
77528

Cavo USB-C / VGA



risoluzioni fino a
1920 x 1080p - 1,8 mt
Codice
51769

Cavo USB-C / DisplayPort



4K 60 Hz, 1,20 m
Codice
51767

Cavo BNC Spina / Spina - Nero



Codice
50046 2 mt
50423 1 mt

Cavo Stereo RCA

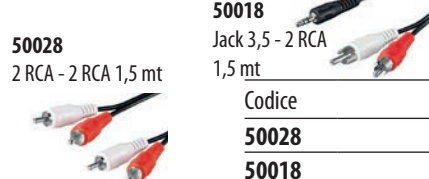

50028
2 RCA - 2 RCA 1,5 mt

50018
Jack 3,5 - 2 RCA
1,5 mt
Codice
50028
50018

Cavi Audio Toslink



Sezione cavo 2,2 mm
Codice Lunghezza
50216 1,0 mt
50447 2,0 mt
11922 Adattatore

Cavi USB-C / USB-C 3.2

Conduttori in rame - Velocità fino a 5 Gbps



Codice
67976 1 mt - nero
66508 2 mt - nero

Cavi USB-C / USB-C 2.0



Codice Lunghezza
66318 1 mt - nero
51244 2 mt - bianco

Cavo USB-C / USB-C High Power



Sync & Charge cavo USB-C™, USB 2.0, 240 W 5A 48V 480Mbps 1 m
Codice
61717

Cavo USB-C / USB-C con display LED

1 m - Ricarica Rapida 5A 100W



Codice
7746

Cavi Multi USB



Cavo 4 in1 da USB-A a USB Tipo-C, Micro-USB, 2x Lightning (iPhone) 1.2m Ricarica Rapida 2.4A Colore Nero
Codice
7748

Cavi Multi USB



Cavo 5 in1 da USB Tipo-C, USB-A a USB Tipo-C, Micro-USB, Lightning (iPhone) 1.2m Ricarica Rapida 3.1A 60W Colore Nero
Codice
7747

Adattat. USB-C / Micro-USB

Converte la presa USB-C™ in presa Micro-USB.

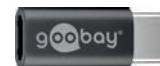

Codice
51597

Cavo Antenna TV Spina-Spina



Codice	Codice	Lunghezza
68145	68146	1,5 mt
68147	68148	2,5 mt

Cavo Antenna TV Spina-Presa



Codice	Codice	Lunghezza
11510	11720	1,5 mt
11511	11722	2,5 mt
11512	11723	5 mt

!! Attenzione !! I prezzi del seguente volantino potrebbero cambiare più volte durante il periodo di validità.

Per essere aggiornati consultare il file Excel scaricabile dal sito Sidium.it nella sezione CATALOGHI DOWNLOAD

Extender con cavo Cat5e/6



58972 HDMI Full HD 1080p Ethernet fino a 60 metri over CAT5/6 con sensori infrarossi per telecomandi



16011 Mini estensore HDMI 1080p Ethernet fino a 50 metri over CAT6

SP1435 Mini estensore HDMI 1080p Ethernet fino a 60 metri over CAT6



Codice

58972

16011

SP1435

Extender VGA



Extender VGA tramite cavo Ethernet - 60 mt

Codice

SWB803

Tastiere Italiane



58928



LKTAST03

Codice

58928

108 tasti rotondi

LKTAST03 Wireless 108 tasti + Mouse Ottico

Mouse



LKM0502 - Wireless 3 tasti - nero - ricevitore USB - 1000dpi



97904 - Con filo 1,8 mt 3 tasti - nero - 800dpi

Codice

LKM0502

97904

Pasta Termica



Codice

COOLP101WT

Pasta Bianca - 8 gr

COOLP400SI

Pasta Argento - 4 gr

Altoparlanti per PC



12 W - Connettore da 3,5 mm - Nero

Codice

CSPR10020BK

Monitor LCD LED 10.1"

Pulsanti touch - Formato 16 : 9 - Contrasto 300 : 1 - Ingressi : HDMI / VGA / AV - Base con biadesivo - Telecomando - Alimentazione tramite accendisigari auto alimentatore inclusi. Cavi di collegamento inclusi



Codice

S56467

Hub USB



70253



LHCCH03



95670

Codice

95670 4 porte - senza alimentatore

LKCCH03 4 porte - 1xUSB3 - cavo con SpC

70253 3 porte USB + 1 RJ45 - cavo con SpC

Sistema Wi-Fi MESH

Dispositivo per ampliare il segnale WiFi

- 5GHz: Up to 867Mbps
- 2.4GHz: Up to 300Mbps



Codice

45201

Router 4G LTE Wi-Fi N300

4G LTE Cat4 fino a 150 Mbps semplicemente inserendo una scheda SIM



Codice

4G03

Wi-Fi Extender 300Mbps



standard di rete IEEE 802.11b, IEEE 802.11g, IEEE 802.11n bande 2.412 ~ 2.484 GHz

Codice

45121

Router Wi-Fi 300Mbps



3 antenne da 5dBi Standard e Protocollo IEEE802.11/b/g/n

Codice

45081

Lettori smart card

NFC6320
Lettore RFID



73263
Lettore card Interfaccia USB 2.0



Codice

NFC6320

73263

Alimentatori ATX

01653 - 500 Watt - Ventola 120 mm - 4 x SATA - 1 x floppy - 2 x PATA - 1 x Molex 4pin

S60180 - 650 Watt - Ventola 120 mm - 4 x SATA - 1 x floppy - 2 x PATA - 1 x PCIE - 2 x Molex 4pin - Cavo alimentazione incluso



Codice

01653

S60180

Ventole Tachimetriche 12 V

Connettore 3 poli



Codice

73258 40 x 40 x 10 mm

38968 50 x 50 x 10 mm

73246 80 x 80 x 25 mm

Barcode Scanner USB e Wireless

Fonte luminosa: laser 650 nm (diodo laser di sicurezza) Simbologie supportate: EAN-8, EAN-13, UPC-A, UPC-E, CODE39, CODE128, EAN128, Codebar, Industrial 2 di 5, Interleave 2 di 5, Matrix 2 di 5, MSI, China Post Code e tutti i codici a barre 1D e 2D



71919
76700

16014

con cavo USB

Codice Collegamento

71919 con cavo USB

76700 Wireless ricev. USB

Telecamera Wifi smart 1280 x 720p con AUTOTRACK, salva su SD/CLOUD

COMPATTA

Insegue automaticamente quello che si muove e registra i suoni



Accesso da smartphone Semplificato - Risoluzione in HD, - Ingresso micro SD - Microfono integrato - Alimentatore incluso - 80 x 70 x 120 mm

Codice

72566

Cavi di Alimentazione



51322-95038

Spina ITA 10A-Presa C7 Nero

51326

Spina ITA 10A-Presa C7 Bianco

97203

Spina ITA 10A Presa VDE - Nero

50081

Spina VDE - Presa VDE Nero

97203

Spina ITA 10A Presa VDE - Nero

50081

Spina VDE - Presa VDE Nero

68604

Spina Schuko 90° Presa VDE - Nero

93119

Spina Schuko 90° Presa VDE 90° - Nero

68604

Spina ITA 10A - Presa Compaq 3 poli - Nero

Codice

51322

2 mt

95038

3 mt

51326

2 mt

97203

1,8 mt

550081

2 mt

96045

Spina ITA 10A - Presa Compaq 3 poli - Nero

96045

1,8 mt

68604

1,5 mt

93119

5,0 mt

!! Attenzione !! I prezzi del seguente volantino potrebbero cambiare più volte durante il periodo di validità.

Per essere aggiornati consultare il file Excel scaricabile dal sito Sidium.it nella sezione CATALOGHI DOWNLOAD

Lampada da lavoro



HISS1601
Forbice 160 mm
Certificata VDE
1000 V



HES02855
Forbice 145 mm

Codice
HISS1601
HES02855

Utensili isolati

CERTIFICATI 1000V, VDE/GS



HIKPS28318
Set 3 pinze



HKISD0308
Set 3 cacciaviti

HKISD0608 Set 6 cacciaviti



Codice
HIKPS28318
HKISD0308

Stagno tradizionale 60/40



Codice

TIN10020 Ø 1,0 mm - 20 gr
TIN080100 Ø 0,8 mm - 100 gr
TIN10100 Ø 1,0 mm - 100 gr
TIN10250 Ø 1,0 mm - 250 gr

Spray tecnici



L-15



A-34F



G-20



V-66



M-33



R-11



390CCS/GL



390DCS/GL



390ACS/GL

Codice

L-15 Alcool Isopropilico - Lattina - 1 lt
A-34F Congelante Infiamm. 400 ml
G-20 Pulisci Contatti secco - 200 ml
V-66 Lacca Isolante trasparente 200 ml
M-33 Lubrificante tecnico 200 ml
R-11 Pulisci contatti con additivo 200 ml
390CCS/GL Pulisci Contatti oleoso - 200 ml
390DCS/GL Pulisci Contatti secco - 200 ml
390ACS/GL Alcool isopropilico - 400 ml

Saldatura

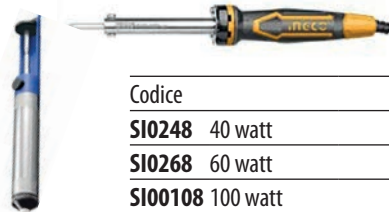

51200

Codice

SI0248 40 watt
SI0268 60 watt
SI00108 100 watt
51200 Aspirastagno

Solder station 2 in 1



Stazione ad aria calda + saldatore 50W, display digitale a led, le due sezioni possono essere utilizzate indipendentemente senza disturbarsi,

Codice

SQ248

Kit Cacciaviti di precisione



HKIPSD0601

Set 6 cacciaviti isolati

Codice

HKIPSD0601
HKSD0718

HKSD0718

Set 7 cacciaviti

Cercafase



HSDT1408
3 x 140 mm



77011 - Set 2 pcs
140 - 190 mm

Codice

HSDT1408
77011

Lampade LED con lente



60361 - 64989
Morsetto con lente ingrandimento -
650 lm - lente 127 mm - 1,75x

Codice Colore

60359 bianca
64990 nera
60361 bianca
64989 nera

60359 - 64990
Morsetto/tavolo
con lente ingrandimento
480 lm - lente 100mm - 1,75x

Multimetri



22103 - Professionale -
LCD - 12 funzioni



DM6012 - con
display RMS super
select



38970 - Multimetro
analogico



94734
Multimetro
digitale
compatto

Codice

DM200
DCM2001
94734
38970
DM6012
48568
22103



DM200 - LCD a 3
cifre, 7 segmenti,
15mm di altezza



DCM2001 - Cor-
rente AC: 2A / 20A
/ 200A



48568 - Telemetro a
ultrasuoni 12 mt

Stazione saldante 60 Watt



Stazione di saldatura 60
Watt - Controllo potenza
regolabile

Codice

SQ792

Spelacavi



HWSP15608
• Diametro fili:
0,5-6mm • Con
funzione taglio



11945 - 4 lame per cavi con
diametro 3,2 - 9,5 mm • 22 AWG

Codice

11945

HWSP15608

Crimpatrice



per spine modulari con
tagliacavi da 4, 6, 8 pin
tipo RJ 10, RJ 11, RJ 12, RJ 45

Codice

77146

Pistole e colla a caldo

59176
40W



GG148
100W



AKTGS2061
Blister 6 pcs
Ø 11,2 x 200mm

Codice

59176
GG148
AKTGS2061

Colla Cianoacrilica

77002



77012

Codice

77012 20 gr
77017 10 gr
77002 3 gr

77017

Spine - Prese Elettriche



IMBALLO SHRINK PACK +
CODICE A BARRE

Bianco	Nero
10217	10218
10221	10222
10219	10220
8747	
10239	10240
10227	
10223	10224
10225	10226
8006600	8006610
8006500	8006510



Spine - Prese Elettriche smontabili e calpestabili

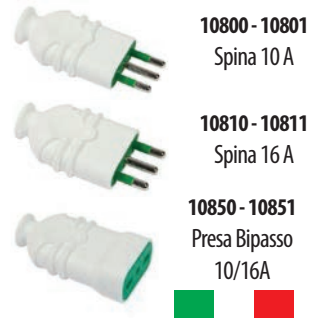

Bianco	Nero
10800	10801
10810	10811
10850	10851

Kit adattatori viaggio

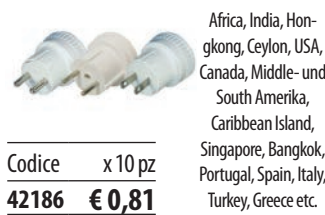

Codice	x 10 pz
42186	€ 0,81

Avvolgicavo con protezione Termica



Codice Lunghezza - Prese

8700	5 mt - 2 Bipasso
8701	10 mt - 4 Bipasso/Schuko
8703	25 mt - 4 Bipasso/Schuko - in metallo

Prolunghe Elettriche



Spina 16 A - Presa Bipasso

Bianco	Nero		
10260	5001N	3 mt	3 x 1 mmq
10261	10259	5 mt	3 x 1 mmq
5006B	5006N	3 mt	3 x 1,5 mmq
5007B	5007N	5 mt	3 x 1,5 mmq
5008B	5008N	10 mt	3 x 1,5 mmq

Spina 10 A - Presa 10 A

Bianco	Nero		
5003B	5003N	2 mt	3 x 0,75 mmq
5004B	5004N	3 mt	3 x 0,75 mmq
5005B	5005N	5 mt	3 x 0,75 mmq
10571			prolunga estensibile

Multiprese Elettriche Spina 10 A



Codice	Prese
7034B	4
7024B	4
7026B	6

Adattatori industriali



Codice
10300
10301

Multipresa Elettrica con interruttori individuali



Codice	Prese
10256	4 Schuko / Bipasso
10254	6 Schuko / Bipasso

Multiprese Elettriche



Codice	Con interruttore luminoso
16012	2 Bipasso + 1 Schuko/Bipasso
10253	6 Bipasso + 3 Schuko/Bipasso+Interr
10233	8 Bipasso + 4 Schuko/Bipasso+Interr

Multiprese Elettriche Prese Universali Bipasso/Schuko



Prese	Bianco	Nero
3	10235	
4	10237	
5	10229	
6	10251	10252

Multiprese con prese bipasso



Codice	Prese
8708	3
8706	5
8741	5
8709	6

!! Attenzione !! I prezzi del seguente volantino potrebbero cambiare più volte durante il periodo di validità. Per essere aggiornati consultare il file Excel scaricabile dal sito Sidium.it nella sezione CATALOGHI DOWNLOAD

Chiodini fissacavo



Codice	
17077	Ø 5 mm
17078	Ø 6 mm
17079	Ø 7 mm
17080	Ø 8 mm
17082	Ø 10 mm

Morsetti isolati professionali



Striscia da 10 morsetti
Prezzo a striscia

Codice		Codice	
18001	1,5 mm ²	18006	6 mm ²
18002	2,5 mm ²	18010	10 mm ²
18004	4 mm ²	18016	16 mm ²

Timer Elettrici

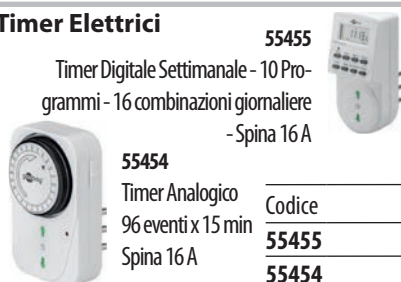

Timer Digitale Settimanale - 10 Programmi - 16 combinazioni giornaliere - Spina 16 A

55455	
55454	Timer Analogico
	96 eventi x 15 min
	Spina 16 A
	Codice
	55455
	55454

Supporto per condizionatori d'aria



In acciaio.
Larghezza 775mm
Altezza 365mm
Lunghezza sostegni 400mm
interasse max fori clima 328mm. Larghezza sostegni da 200mm a 700mm

Codice	
18502	

Terminal block



24A 300V
0,5-2,5mm

Codice	Posizioni
7200060	2
7200070	3
7200090	4
7200080	5

Morsetti serrafilo



Codice	Poli
7200100	2
7200110	3
7200120	5

Pressacavo IP68



Codice	
18307	PG-7
18309	PG-9
18311	PG-11
18313	PG-13
18316	PG-16

Viti per scatole 503



	Codice
14600 L. 50 mm - Conf 10 pcs	14600
14635 L. 35 mm - Conf 50 pcs	14635
14650 L. 50 mm - Conf 50 pcs	14650
14670 L. 70 mm - Conf 50 pcs	14670

Kit Prese Telecomandate



Spina 16A - Prese Bipasso

Codice	
710001	

Cronotermostato



Giornaliero - settimanale
Carico max 6(2)A 230V - Range temperatura: 5°-35°C - Antigelò: 7°C - Relè: (NO/NC)

Codice	
48553	

Termostati

TM001M - Senza alimentazione
Intervallo di lavoro 5 .. 30°C
Sensore Ad espansione di gas



Made in Italy
Oseitron

TAD02M - Digitale - funzione antigelo montaggio a parete 230V



Codice	
TM001M	
TAD02M	

Termostati smart wi-fi

Permettono di programmare la temperatura di casa in maniera semplice e veloce, controllando e modificando le impostazioni in qualsiasi momento e luogo sia in casa che da remoto grazie alla connessione Wi-Fi e alla compatibilità con gli assistenti vocali Google Assistant ed Amazon Alexa. Sono corredati di adattatore per scatole a muro 3 moduli tipo 503.

710028



710030



Codice	
710028	
710030	

Ventole da incasso

8005100 - Foro incasso ø 100 mm
8005120 - Foro incasso ø 120 mm



8005170 - Foro incasso ø 100 mm



Codice	Watt
8005100	12
8005120	15
8005170	12 € 8,59

Nastro isolante nero



Codice	
7500080	15 mm x 10 m
7500120	19 mm x 20 m
44852	25 mm x 25 m

Compatibili T1 INT - LGT



Presse bivalente 10-16A
SEL2230 - Bianco
SEL2140 - Nero



SEL2320
Deviatore unipolare 16 A - nero

SEL2300 - Presse bivalente 10-16A + schuko - Nera



Codice	
SEL2230	
SEL2300	
SEL2320	
SEL2140	

Compatibili T2 VMR - PLN

Presse bivalente 10-16A 250V
SEL1998 - Bianco
SEL2144 - Nero



SEL2156
Presse schuko 3.0 bianca

SEL1974
Placca 3P - Bianca



Codice	
SEL1998	
SEL2156	
SEL2144	
SEL1974	

Compatibili T3 MTX

SEL2072
Placca 3 posti IP55



SEL2052
Presse Bivalente Bianca 10A 250V



SEL2040
Presse Schuko 16A 250V Bianca

SEL2037
Falso polo bianco



SEL2146
Interruttore Bipolare 16A 250V



SEL2070
Placca 3P - Bianca

Codice	
SEL2040	
SEL2052	
SEL2072	
SEL2037	
SEL2070	
SEL2146	

Compatibili T8 - MGC

2045
Presse bivalente 10/16A



2003
Deviatore unipolare 10A



5 Anni di garanzia

2603
Supporto 3 fori



2022
Placca 7 posti ciliegio



Codice	
2045	
2603	
2003	
2022	

Compatibili T9 LIV - CLC

2045/TL
Presse Bivalente 10/16A - Nera



2003/TL
Deviatore unipolare 10A



5 Anni di garanzia

2603/TL
Supporto 3 fori

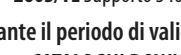

Codice	
2045/TL	
2603/TL	
2003/TL	

!! Attenzione !! I prezzi del seguente volantino potrebbero cambiare più volte durante il periodo di validità. Per essere aggiornati consultare il file Excel scaricabile dal sito Sidium.it nella sezione CATALOGHI DOWNLOAD

Videocitofoni



620204 2 fili schermo 4,3" monofamiliare



620207 2 fili schermo 7" monofamiliare

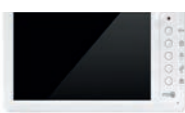

620206 - Monitor aggiuntivo x 620207 e 620217

Codice

620110

620204

620207

620227

620206



620110 4 fili schermo 4,3" monofamiliare

6200227 - 2 fili 2 schermi 7" bi-familiare



Campanelli con sensore



560201 - Rilevatore di presenza allarme con campanello. Angolo 140° portata 8 mt. Alimentazione batteria 9V



5800090 Campanello wireless con sensore a infrarossi. 36 melodie disponibili- Angolo di rilevamento: 100° regolabile. Distanza di rilevamento: 3-7m. 3xAAA (non incluse)



5800080 Campanello wireless con sensore a infrarossi. 36 melodie disponibili- Angolo di rilevamento: 100° regolabile. Distanza di rilevamento: 3-7m. 3xAAA (non incluse)

Codice

560201

5800080

5800090

Spioncino Digitale



Spioncino digitale universale per porte di qualsiasi tipo e spessore. Permette lo scatto di immagini e la registrazione di video tramite pressione del pulsante.

FOTO + VIDEO

Codice

365042

Sonde nylon testa fissa



Codice

18405 4 mm x 5 mt

18410 4 mm x 10 mt

18415 4 mm x 15 mt

Muffole stagne con gel



Utili per rendere stagni collegamenti di cavi elettrici all'esterno

Codice

18823 con GEL 5 x 6 mm²

18822 con GEL 3 x 6 mm²

18821 con GEL 3 x 0,5 - 1,5mm²

Campanelli e citofoni



620005 - Universale e compatibile con tutte le marche - 4 fili + N - Apertura elettroserratura



620006 - Monofamiliare con unità esterna - 2 fili - Apertura elettroserratura



600016 - Campanello wireless a batteria waterproof, 16 suonerie, portata 20m



5800050 - Campanello digitale senza fili. 36 melodie. Volume: 75dB portata 80 mt



Codice

600016

620005

620006

5800050

5800060

Guaine termorestringenti

SWB1222 - Kit 328 pcs varie misure e colori



Codice Diametro int.

SWB1222 Kit 328 pcs

43346 Ø 3,0 mm

62705 Ø 4,0 mm

62718 Ø 5,0 mm

62717 Ø 7,0 mm

43403 Ø 10,0 mm

43263 Ø 12,0 mm

Matasse da 100 mt - Nero

Assortimento capicorda



Assortimento di 175 capicorda preisolati in 18 formati differenti

Codice

42754

Contattori modulari **EBASEE**



Codice

EBS5CH2P63P7 2P - 63 A - 2 NO

EBS5CH4P25P7 4P - 25 A - 2 NO + 2 NC

Interruttori magnetotermici differenziali 1P+N **EBASEE**



Codice

EBS5BL1PNC16AC30 16 A

EBS5BL1PNC20AC30 20 A

EBS5BL1PNC25AC30 25 A

Salvamatore



Codice Portata

EGV2M14 6 - 10 A

EGV2M16 9 - 14 A

Timer



Codice

25000 Temporizzatore luci scale - 12A

25002 Timer giornaliero 16A

25003 Timer giornaliero 18A digitale

25001 Timer

Sezionatore 2P - 25A **EBASEE**



Codice

EBS5G2P25

Differenziale BTicino®



Differenziale 2P
25A - 2 moduli

Codice

BTIGC723AC25

Alimentatori guida DIN



Codice

59573 12 Vdc - 1,25 A

59574 5 Vdc - 2,4 A

Giunti per cavo IP68



81325 - 81292

Codice Ø cavo

81325 5 - 9

81292 6 - 12

81286 8 - 12

!! Attenzione !! I prezzi del seguente volantino potrebbero cambiare più volte durante il periodo di validità.

Per essere aggiornati consultare il file Excel scaricabile dal sito Sidium.it nella sezione CATALOGHI DOWNLOAD

Audio Video Grabber USB 2.0

Permette di acquisire Audio e Video ad alta qualità direttamente dalla porta USB dal PC
Ingresso : USB tipo A - Uscita : 3 RCA + mini 5 pin



Codice
71884

Convertitore Audio

Da Toslink Digitale a
RCA Analogico



Codice
73124

Switch KVM 2 porte

KVM Switch Box 2 porte consente di collegare tastiera USB, mouse USB e monitor a 2 PC, controllabili facilmente tramite il pulsante



Codice
SP1389

Adattatore USB- seriale RS232



Codice
95435

Splitter HDMI 4K

58484 - 60 Hz



58483 - 60 Hz

58482 - 30 Hz



Codice	Uscite
SK835	2
58483	4
58482	4
58484	8

SK835 - 30 Hz

Splitter VGA 4 porte



250 MHz con
alimentatore

Codice
VGA204

Adattatori HDMI - VGA con Audio



68793



51758



44794

44793



Codice
44793 HDMI M - VGA F
44794 HDMI F - VGA F
68793 HDMI M - VGA F
51758 HDMI M - VGA F

Adattatore Scart



97748 - Spina / Presa SCART
passante con
presa Jack Stereo 3,5 mm



50123 - Audio video IN-OUT, Spina
scart / 3 prese RCA + Presa mini-DIN

Codice
97748
50123

Switch HDMI 4K@60Hz



S73127



58489



58488 - manuale

Codice
S73127 3 ingressi - 1 uscita
58488 3 ingressi - 1 uscita
58489 4 ingressi - 1 uscita

Switch manuale HDMI Bi-Direzionale 4K



consente di collegare 2 sorgenti hdmi ad un monitor o ad una tv oppure il contrario.
Codice
S71629

Splitter audio digitale



3 x prese TOSLINK fibra
ottica

consente di collegare un dispositivo come un laptop o un sistema hi-fi a 2x amplificatori.

Codice
11921

Convertitori Scart <> HDMI



Codice
S71628 da Scart a HDMI
S71627 da HDMI a Scart

Adattatori Bluetooth



Bluetooth

Converte un segnale Audio Bluetooth in segnale AUX tramite jack 3,5 mm stereo
- batteria al litio ricaricabile integrata - Autonomia 8 ore
- Microfono integrato

Codice
94710

Convertitori da HDMI <> AV

SK325 Convertitore da
HDMI a RCA AV- 1080p



Codice
SK325
97961

97961 Convertitore da
RCA AV a HDMI- 1080p

Convertitori USB-C

SADAT81 - da USB-C
a VGA F



62107 - da USB-C a
HDMI + VGA F



Codice
62107
SADAT81

Convertitori Display Port - VGA



60606 - da DisplayPort
a VGA F



SADAT19 - da
DisplayPort a VGA F
Codice
60606
SADAT19

Splitter Display Port



Splitter 2 porte risoluzione : 4K@30Hz
DisplayPort M + USB-A
M > 2 x DisplayPort F

Codice
SADAT136

!! Attenzione !! I prezzi del seguente volantino potrebbero cambiare più volte durante il periodo di validità.
Per essere aggiornati consultare il file Excel scaricabile dal sito Sidium.it nella sezione CATALOGHI DOWNLOAD

Gufo scaccia volatili



Gufo scaccia, piccioni, colombi, corvi, effetti luminosi e sonori, con sensore, a batterie 2 x AA (non incluse)

Codice

84010

Scaccia topi



Alimentazione: 220 V
Raggio azione: 50 mq
Frequenze : 20 - 70 kHz

Codice

62316

Scaccia gatti e volatili

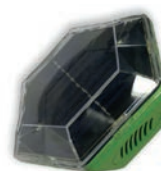

ultrasonico con flash LED, per esterno, con pannello solare
Frequenze: 8000 - 32000 Hz
Carica: solare con pannello o con alimentatore USB non incluso - Raggio azione: 100 mq

Codice

70600

Scaccia talpe, topi, formiche



70048
a batterie, da esterni, 400-1000Hz, + vibrazione copre 1250 mq, tubo in alluminio



70010
a batterie ricaricate con energia solare, da esterni, 400-800Hz, copre 700 mq

Codice

70048 da interno - 220 V

70010 a batterie - 4 x AAA

Repellente per cinghiali



Repellente per animali selvatici, IP54, flash BLU intermittente

Codice

92120

Zanzariera elettrica



Potenza 17W- 2 lampade da 6W incorporate- Raggio di copertura fino a 30mq

Codice

INN-193

Doppio pulsante a bilancere

Fissaggio ad incasso • Corpo in plastica • Terminali faston
Dimensioni L 21,5 x H 28 mm Portata 16A



Codice

94850

Interruttore luminoso 220V

Fissaggio ad incasso • Corpo materiale plastico • Terminali faston • Dimensioni L 10 x H 28 mm Portata 250Vac 16A



Codice

92835 Rosso

Interruttore luminoso 220V

Fissaggio ad incasso • Corpo in materiale plastico • Terminali a saldare • Dimensioni diametro 19 mm • Portata 220 Vac 10A



Codice

92820

Interruttori a Bilancere 220V

Fissaggio ad incasso • Corpo in materiale plastico • Terminali faston • Dimensioni: L 8,5 x H 13,5 mm • Portata 250 Vac 3A



Codice

92824 Rosso

92823 Nero

Interruttori Luminosi 220 V

Fissaggio ad incasso • Corpo in materiale plastico • Terminali faston • Dimensioni: L 22 x H 30 mm • Portata: 250 Vac - 16 A



Codice

820PE57 Giallo

820PE58 Rosso

820PE59 Verde

Pulsanti 220 V

Fissaggio a vite • Corpo in ottone nichelato e plastica • Terminali a saldare • Dimensioni: Ø 16 mm • Portata: 220 Vac - 1 A



Codice

92808 Nero

92809 Rosso

Deviatori a leva 220V

Fissaggio a vite • Corpo in ottone nichelato • Terminali a vite • Dimensioni: Ø 12 mm • Portata 250 Vac 15A



Codice

592817 Unipolare

592818 Bipolare

Microswitch

Deviatore • Unipolare • Leva dritta • 250 Vac 5A



Codice

10185

Interruttori passafilo



Codice

10314 Nero

10310 Bianco

Cuffie e auricolari



10-1041MA - Cuffia bluetooth con cancellazione attiva rumore



SN090 - Auricolari con microfono Jack 3,5mm



SN070 - Auricolari con microfono Jack 3,5mm



97580 - Cuffia TV con controllo volume amplificato
Cavo 6 mt



BTX49 - Auricolari in-ear bluetooth



HPBT2052WT - Auricolari in-ear bluetooth

Codice

97580

BTX49

HPBT2052WT

SN090

SN070

10-1041MA

Supporti TV



Codice	
T10001	30 Kg - inclinabile - da 13" a 37"
91363	15 Kg - 3 movimenti
91364	15 Kg - 4 movimenti

Supporti TV



Codice	
HP41C	37" - 70"
HP51	32" - 70"

Supporto TV da 37" a 70"



Codice	Max 40 Kg
63487	Vesa fino 600 x 400 mm

Supporti TV da tavolo

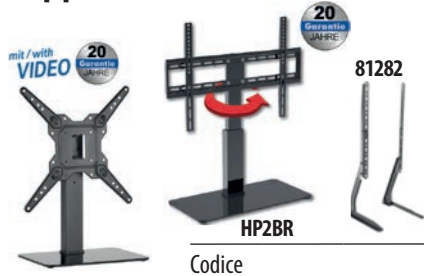

Codice	
HP2H	23"-55"
HP2BR	32"-65"
81282	23"-70"

Supporti TV

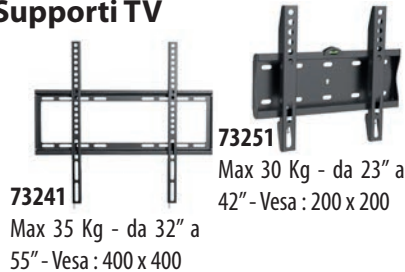

73241	Max 35 Kg - da 32" a 55" - Vesa : 400 x 400
73251	Max 30 Kg - da 23" a 42" - Vesa : 200 x 200

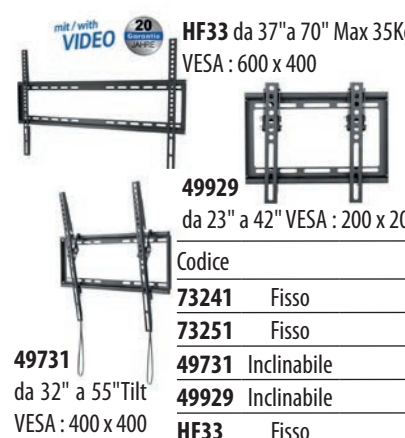

HF33	da 37" a 70" Max 35Kg VESA : 600 x 400
49929	da 23" a 42" VESA : 200 x 200
Codice	
73241	Fisso
73251	Fisso
49731	Inclinabile
49929	Inclinabile
HF33	Fisso

Telec. Univer. Preprogrammati

Codice	Marca sostituita
97903	Philips
94926	Samsung
97964	Samsung & Lg SMART
94927	LG
94928	Sony
94930	Panasonic
94931	Tutti i decoder SKY
94932	Telefunken
80452	LG-Sams-Sony-Phil-Pan
80643	LG-Sams-Sony-Phil-Pan

Telec TV universali programmabili da PC

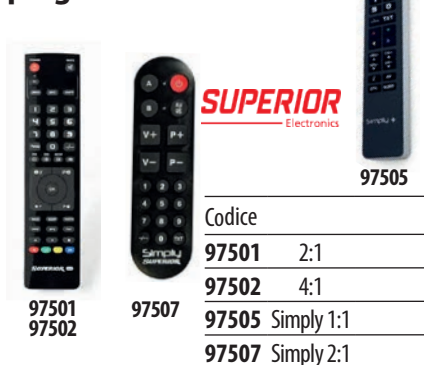

Codice	
97501	2:1
97502	4:1
97505	Simply 1:1
97507	Simply 2:1

Telecomandi universali per condizionatori



Codice	
97511	4000 modelli in memoria
45252	1000 modelli in memoria
16056	6000 modelli in memoria

Radiocomando Universale Rolling

Code codici fissi e variabili

Radiocomando con un ventaglio di Frequenze multiple molto ampio, utilissimo per duplicazione vecchi radiocomandi con frequenze obsolete.

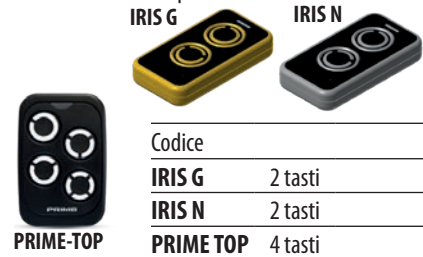

Codice	
IRIS G	2 tasti
IRIS N	2 tasti
PRIME TOP	4 tasti

Radiocomando Universale Quarzato

Universale a codice fisso frequenza quarzata, il quarzo deve essere installato alla frequenza richiesta



Codice	
JQ088-4	Blu
JQ000-4	Nero

Radiocomando universale quarzato

Radiocomando auto apprendimento con codice fisso per sostituire i vecchi telecomandi quarzati

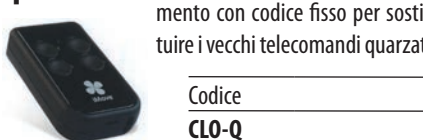

Codice	
CLO-Q	

Radiocomandi Originali



Codice	
787007	XT2 433 SLH-FAAC
787009	XT2 868 SLH-FAAC
D111904	MITTO BICANALE-BFT
TXQ449200	BICANALE - CARDIN
6100332	KILO TX2 JLC 868 MHZ-GENIUS
001TOP-432EE	BICANALE - CAME
FLO2RS	BICANALE - NICE
41905-004	QUADRICANALE APRIMATIC
9863173	TO.GO 2W A BENINCA
INTI	BICANALE 433,92 Mhz NICE

Radiocomando Universale Rolling

Code codici fissi e variabili



Universale autoapprendente a codice fisso, rolling code Freq variabili 433,92 / 868 MHz , colore nero
Codice
ARGO-WHY

Radiocomandi Universali fissi 433 MHz

Universale - Frequenza fissa 433,99 MHz
Possibilità di programmare fino a 4 dispositivi
Codice
10311
42751
42751

Centraline apricancello 2 canali



Codice	
10276	x Esterno - 433,92 MHz
10275	x Esterno - 433 MHz
10278	x Interno - 433 MHz

!! Attenzione !! I prezzi del seguente volantino potrebbero cambiare più volte durante il periodo di validità.

Per essere aggiornati consultare il file Excel scaricabile dal sito Sidium.it nella sezione CATALOGHI DOWNLOAD

Amplificatore stereo



USB, SD, Bluetooth, karaoke, telecomando. Nero **Doppia** Codice
alimentazione : 220V / 12V **38993**

Amplificatore PA 100V

90 W - 4 Zone selezionabili - Ingressi: USB - SD - FM - BLUETOOTH - 3x LINE 1x Uscita LINE Display e Telecomando 2x Ingressi Mic **72199**



Casse Amplificate



Ingresso LINE e MIC amplificati Controlli: MIC, ECO, BASSI, ALTI, Volume Master Sistema Bass reflex 2 vie Griglia in metallo Prese sul retro XLR/RCA/ J6.35mm

Codice	
71652	8" - 100 W
71654	10" - 150 W
71656	12" - 250 W

Cinghie per giradischi



Codice	quadrate
22174146	74 x 1,2 mm
22282013	64 x 1,2 mm
22174140	49 x 1,2 mm

Codice	piatte
22282064	187 x 5 x 0,6 mm
2290727	82 x 6 x 0,55 mm
2290715	60 x 4 x 0,7 mm

Cavo Schermato LF - 100 mt



microfonico Ø 6 mm - 2 x 0,5 mm in RAME Codice **47108**

Piattina Rosso Nero 100 mt CCA



Codice	Sezione
67728	2 x 0,35 mm
56707	2 x 0,50 mm
15022	2 x 0,75 mm
56705	2 x 1,00 mm
15023	2 x 1,50 mm

Cavo Rete CAT5 U/UTP

Conduttori in CCA Guaina in PVC - Conforme CPR

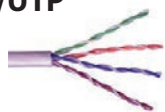

Codice	mt	
SEA210E	305	Solido
95409	305	Flessibile
68707	100	Flessibile

Radiomicrofoni wireless



71670
Kit 1 Microfoni a gelato + Ricevitore VHF 1 Ch - Display LCD - Antinterferenze



56379
Kit 2 Microfoni a gelato + Ricevitore UHF 2 Ch - Antinterferenze



56725
Microfono wireless UHF con ricevitore Wireless USB
Codice **71670**
56725
56379

Microfono con filo



Dinamico Unidirezionale
Codice **72197**

Giradischi digitali

Digitalizzazione di dischi in vinile su USB o scheda SD fino a 32 GB - Bluetooth 2.0 - Con speaker interni. Ririproduzione (MP3/WMA) da USB o scheda SD fino a 32 GB



TX22
con lettore cassette audio



10-5551MA



TX186



10-5562MA

Codice
TX22
10-5551MA
10-5562MA
TX186

Cavo telefonico in rame - 100 mt



1 coppia - 2 x 0,60 mm
Codice **14500**

Cavo elettrico 3 x 1,5 mm² - 100 mt



Codice
CAV-3X15B Bianco
CAV-3X15N Nero

Cavi Coassiali RG 100 mt



Codice
67091 RG-59
50093 RG-58

Cavo Rete CAT6 U/UTP

Conduttori in CCA Guaina in PVC - Conforme CPR

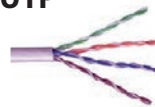

Codice	mt	
SEA310E	305	Solido
95694	100	Solido

Megafoni



72192 20W con microfono incorporato, - Memoria per 8 secondi di registrazione



56532 35W con lettore USB - SD Microfono integrato e mobile.



72196 60W con lettore USB - SD Microfono integrato e mobile.

Codice
72192
56532
72196

Stativi per speaker

71651 - Kit 2 stativi + borsa di trasporto - Altezza max 1,8 mt - Max 30 Kg



72535 Stativo singolo - Altezza max 1,8 mt - Max 30 Kg



Codice
71651
72535

Cassa amplificata portatile a batterie



Party, kit cassa acustica amplificata 700W, 12"/30cm, bluetooth, SD, USB, telecomando, microfono UHF. Con effetti luminosi.

Codice **58963**

Cavo allarme CCA schermato - 100 mt



Codice	
GL89.100	4 x 0,22 + 2 x 0,5mmq
GL89.800	2 x 0,22 + 2 x 0,5mmq
14101	2 x 0,22 GR3

Cavi Coassiali TV in matassa in CCS



Codice	Classe	Diam.	Matassa
AV71100	A	5,1 mm	150 mt
AV71200	A	6,8 mm	100 mt
AV70080	B	5,1 mm	100 mt
AV70090	B	6,8 mm	100 mt

Cavo TV in Rame - Classe A+



Confezione Rollbox

Codice	Ø	mt
AV71500	5,1	150
AV71600	6,8	100

!! Attenzione !! I prezzi del seguente volantino potrebbero cambiare più volte durante il periodo di validità. Per essere aggiornati consultare il file Excel scaricabile dal sito Sidium.it nella sezione CATALOGHI DOWNLOAD

Alimentatori USB da auto

2 porte USB-A
ingresso 12/24 V



Codice	A	Colore
44177	2,4 A	nero
58912	3,1 A	nero
71897	4,8 A	nero

Alimentatori USB



Codice	W	Porte USB	Colore
44947	5W	1 x A	nero
44948	5W	1 x A	bianco
44951	12W	2 x A	nero
44952	12W	2 x A	bianco
53864	20W	1 x C	nero
53865	20W	1 x C	bianco
44956	28W	2 x A	nero
44962	30W	4 x A	bianco
40772	65 W	cavo 1 x C	nero
65419	65 W	cavo 1 x C	nero
64817	68W	2 x C+2 x A	nero
64818	68W	2 x C+2 x A	bianco
65420	90W	cavo 1 x C	nero

Trasformatore Elettronico



Per lampade alogene
a bassa tensione

Codice	
ETPAR105I	35-105w - 11-12 volt
ETPAR70I	20-70w - 11-12 volt

Alimentatore per videosorveglianza

12V - 1,5 A con spina DC
5,5 x 2,1 mm - Senza
spina rete



Codice
AL15R

Alimentatori per Strisce LED 12V



Codice	W
30005	15
30002	20

Alimentatori Universali 6 plug



Connettori DC: 5,5 x 2,5/
5,5 x 2,1 / 5,5 x 1,5 /
4 x 1,7 / 3,5 x 1,35

Codice	Vdc	Potenza
HB022N	3/4,5/5/6/7,5/9/12	0,6 A
HB028N	3/4,5/5/6/7,5/9/12	1 A
HB029N	3/4,5/5/6/7,5/9/12	1,5 A
HB042N	3/4,5/5/6/7,5/9/12	2,25 A
HB041N	9/12/13,5/18/20/24	1,5 A

Alimentatore x Strisce LED metallici - IP20



vito

Codice	V	W	Dimensioni mm
6240400	12	25	104 x 30 x 23
6240420	12	36	120 x 40 x 32
10291	12	60	160 x 40 x 32
10292	12	100	190 x 47 x 36
10293	12	120	190 x 47 x 36
6240510	12	150	200 x 40 x 60
6240520	12	200	224 x 69 x 40
94752	24	60	
6240630	24	100	
94751	24	120	
94748	24	350	

Alimentatore 5V - 2 A



spina DC 5,5 x 2,0 mm

Codice
ST705

Alimentatore 9V - 4A



spina DC 5 x 2,5 mm

Codice
ST301

Alimentatori 12 V plastici

94733	71848
	10299
	54782

Connettore dc : 5,5 x 2,1 x 1,0 mm

Codice	Potenza
ST802	1500 mA - 18 W
94733	1500 mA - 18 W
ST701	2000 mA - 24 W
ST358	2000 mA - 24 W
71848	2500 mA - 30 W
6240710	3000 mA - 36 W
54782	3300 mA - 42 W
6240720	5000 mA - 60 W
10299	6500 mA - 78 W

Alimentatori universali 3 - 12 V

11 connettori DC



Codice	
64571	0,7 A
64568	1 A
64569	1,5 A
64570	2,25 A

Alimentatori universali per notebook

21900 - Automatico 90 W - 10
connettori da 15 a 20V

21389 - 90 W - 9 connettori
15/16/18/19/20/24V - 1 porta USB

71623 - Automatico 90 W

12 connettori - da 12 a 20V
1 porta USB

21519 - 75 W

8 connettori -
12/15/16/18/19/20V



Codice
71623
21900
21519
21389

Alimentatore Universale 96W

Tensioni uscita : 12-15-16-

18-19-20-24V Connettori

DC : 4 x 1,7 / 4,8 x 1,7 / 5

x 1,4 / 5,5 x 1,5 / 5,5 x 2,1

/ 5,5 x 2,5 / 6 x 1,4 / 6,3 x 3



Codice
ST570

Caricabatterie Apple Watch



compatibile con tutti i modelli da
serie 2, incluso adattatore USB
Cavo 1 mt

Codice
65343

Alimentatori 24V plastici

Uscita Jack 2,1 mm



Codice	
43571	78W - 3,65A
3264	60W - 2,5A

Gruppi di continuità



Protezione contro sovraccarichi e cortocircuiti -
Onda sinusoidale modificata
Filtro per rete LAN

CMDC1100 Uscite 5-9-12Vdc,
adatto x WiFi, Modem, Router, VOIP,
Telecamere, Funzione POE



Codice	
97512	650 VA - 360 W - 2 x prese IEC
97513	1000 VA - 600 W - 4 x prese IEC
97514	1500 VA - 900 W - 4 x prese IEC
CMDC1100	1100 W - 8800 mAh

!! Attenzione !! I prezzi del seguente volantino potrebbero cambiare più volte durante il periodo di validità.

Per essere aggiornati consultare il file Excel scaricabile dal sito Sidium.it nella sezione CATALOGHI DOWNLOAD

Amplificatori TV da palo AEV



Codice	
CU800	2 Ingressi - III - UHF - Gain 10dB
CU804	1 Ingresso - (III+UHF) - Gain 10dB
CU812	2 Ingressi - III - UHF - Gain 20dB
CU813	3 Ingressi - III - 2x UHF - Gain 20dB
CU814	4 Ingressi - III - IV - V - UHF - Gain 20dB
CU817	1 Ingresso - (III+UHF) - Gain 20dB
CU833	3 Ingressi - III - 2x UHF - Gain 30dB
CU834	4 Ingressi - III - IV - V - UHF - Gain 30dB
CU837	1 Ingresso - (III+UHF) - Gain 30dB

Amplificatori retro TV



1 Ingresso - 2 Uscite - VHF - UHF 112dB uV guadagno 20dB regolabile



CU308
1 Ingresso - 2 Uscite VHF-UHF 112dB uV - guadagno 18-24 dB regolabile

Codice
42752

CU308

Antenna UHF Fracarro® RED5 HD 5G

Guadagno 15 dB
Connettore F
Banda 470-694 MHz
Filtro LTE-4G-5G



Minimo ordinabile 10 pz e multipli

Codice
19001

Connettori TV 9,5 mm



91359	Presca	Codice
91358		91358
	Spina	91359

Connettori F



66200 - 66248 - 66231	a vite	Codice	Ø mm
66200			6,8
66248			6
66231			5
65975 - 65944	a crimpare	65975	6,7
		65944	5

Centralini larga banda AEV



Codice	
CU402	4 Ingressi - III - IV - V - UHF - Gain 32dB
CU404	3 Ingressi - VHF - 2x UHF - Gain 32dB
CU432	4 Ingressi - III - IV - V - UHF - Gain 40dB
CU434	3 Ingressi - VHF - 2x UHF - Gain 40dB

Alimentatori Retro TV



Codice	
CU006	1 In - 1 Out - 200mA
SMT210	1 In - 1 Out - 300mA
CU007	1 In - 2 Out - 200mA
SMT200	1 In - 2 Out - 300mA

Antenna tripla UHF

UHF 21-48
Guadagno 15dB
Connettore F
Montaggio rapido
26 elementi
IMBALLO SINGOLO



Codice
97520

Antenna logaritmica B IV-V 5G

16 Elementi - Connettore F
Guadagno 8,5 dB - Filtro 5G
NUOVA VERSIONE
Minimo ordinabile 10 pz e multipli



Codice	Confezione min
S97522	10 pz

Connettori F Doppio OR

AV70120
Ø 6,7 mm

AV70110 - Ø 5,1 mm



Codice
AV70110
AV70120

Ricevitore digitale terrestre SCART Full HD

Snodabile 180° - Riproduzione di video (MKV, AVI, MP4, DiVX), audio (MP3), immagini (JPG, BMP)*



Codice
78242

Ricevitore DVB-T2 HD H265

con DISPLAY, 220v, HDMI, Ethernet, SCART

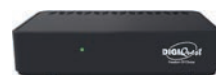

Codice
43287

Ricevitore Stick DVB-T2 HD H.265

Risoluzione video fino a 1080p (Full HD) - Funzione Mediaplayer via USB*: riproduzione di video (MKV, AVI, MP4, DiVX), audio (MP3), immagini (JPG, BMP)
Canali TV e radio memorizzabili



Codice
HEVC 16015

Antenne TV interne LTE FM - VHF - UHF

10333
• Guadagno Max VHF: 30dB UHF: 36dB



ANIR1505BK700

Filtro LTE700 per ridurre l'impatto del 4G • Guadagno 28 dB regolabile



Codice
ANIR1505BK700
10333

Divisori TV / SAT

5 - 2450 MHz - Passaggio CC su tutte le uscite



Codice
67001 1 In - 2 Out
67002 1 In - 3 Out
67003 1 In - 4 Out



Codice
AV20002 1 In - 2 Out
AV20003 1 In - 3 Out
AV20004 1 In - 4 Out

Condensatori Industriali di Spunto 400 / 450 V



Codice	uF	Codice	uF	Codice	uF	Codice	uF
4501.5	1,5	4506.3	6,3	45016	16	45031.5	31,5
4502	2	4508	8	45018	18	45035.0	35
4502.5	2,5	45010	10	45020	20	45040	40
4503.5	3,5	45012	12	45025	25	45050	50
4504	4	45014	14	45030	30	45060	60

!! Attenzione !! I prezzi del seguente volantino potrebbero cambiare più volte durante il periodo di validità. Per essere aggiornati consultare il file Excel scaricabile dal sito Sidium.it nella sezione CATALOGHI DOWNLOAD

LED Goccia 9W

vito



Codice	Attacco E27
92595	Calda - 783 lm
92594	Naturale - 801 lm
92593	Fredda - 819 lm

LED Goccia 11,5 W

vito



Codice	Attacco E27
1515680	Calda - 1012 lm
92791	Naturale - 1035 lm
92790	Fredda - 1058 lm

LED Goccia 15 W

vito



Codice	Attacco E27
97541	Calda - 1335 lm
97542	Naturale - 1365 lm
10279	Fredda - 1395 lm

LED Goccia 18 W

vito



Codice	Attacco E27
1519360	Calda - 1728 lm
1519370	Naturale - 1764 lm
1519380	Fredda - 1800 lm

LED Minisfera 7 W

vito



Codice	Attacco E14
97535	Calda - 514 lm
97536	Naturale - 527 lm
97537	Fredda - 540 lm

LED Minisfera 9 W

vito



Codice	Attacco E14
1517570	Calda - 731 lm
1519430	Naturale - 810 lm
1519440	Fredda - 828 lm

LED Minisfera 6,5 W

vito



Codice	Attacco E27
97544	Calda - 514 lm
97545	Naturale - 527 lm
97546	Fredda - 540 lm

LED Minisfera 8,5 W

vito



Codice	Attacco E27
1517600	Calda - 731 lm
1519460	Naturale - 810 lm
1519470	Fredda - 828 lm

LED Candela 6,5 W

vito



Codice	Attacco E14
92807	Calda - 507 lm
92806	Naturale - 520 lm
92805	Fredda - 533 lm

LED Candela 8 W

vito



Codice	Attacco E14
1517390	Calda - 704 lm
1517400	Naturale - 720 lm
1517410	Fredda - 828 lm

LED Globo 18 W

Codice	Attacco E27
92802	Calda - 1300 lm
92801	Naturale
92800	Fredda - 1901 lm

LED Spot 220V 7 W

Angolo 120°

vito



Codice	Attacco GU10
1515650	Calda - 514 lm
1515660	Naturale - 527 lm
1515670	Fredda - 540 lm

LED Spot 220V 9 W

Angolo 120°

vito



Codice	Attacco GU10
1519500	Calda - 792 lm
1519490	Naturale - 756 lm
1519480	Fredda - 774 lm

LED Spot 12V 6W

Angolo 120°

vito



Codice	Attacco GU5.3
1513700	Calda - 486 lm
1513710	Naturale - 508 lm
1513720	Fredda - 528 lm

LED Fungo 7,7 W

vito



Codice	Attacco E14
92783	Calda - 620 lm
92782	Naturale - 656 lm
92781	Fredda - 691 lm

LED Fungo 9 W

vito



Codice	Attacco E27
92795	Calda - 725 lm
92779	Naturale - 766 lm
94813	Fredda - 813 lm

Lampadina LED Tubolare 9 W

vito

Dimensioni
Ø 37 x 120 mm



Codice	Attacco E27
1515410	Calda - 675 lm
1515420	Naturale - 702 lm
1515430	Fredda - 720 lm

LED Maxi T120 E27

vito



Codice	Colore
92573	20 W Freddo
1518510	30 W Freddo
92570	40 W Freddo
1518530	50 W Freddo

Lampadine LED con sensore - E27

Con crepuscolare - 9 W Sensibilità 15 lux
1519020 - Naturale
1519030 - Fredda
Con sensore PIR - 11 W -
1518550 - Naturale
 Raggio azione: 5 mt



Codice	
1519020	
1519030	
1518550	

Lampadina RGB Smart Wi-Fi

Attacco E27 - 10 Watt
850 Lumen



Codice
1518700

!! Attenzione !! I prezzi del seguente volantino potrebbero cambiare più volte durante il periodo di validità.
 Per essere aggiornati consultare il file Excel scaricabile dal sito Sidium.it nella sezione CATALOGHI DOWNLOAD

LED Filamento Goccia 9W



vito

Codice	Attacco E27
1514430	8 W Calda
1514440	8 W Naturale
1514450	8 W Fredda
1518200	10 W Calda
1518210	10 W Naturale

LED Filamento Goccia opache - 10W



vito

Codice	Attacco E27
1518400	Calda
1518410	Naturale

LED filamento vintage

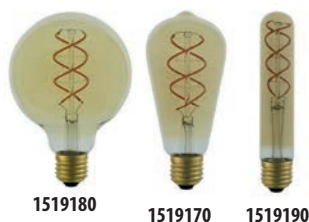

1519180

1519170

1519190

Codice	Attacco E27
1519180	4 W calda
1519170	4 W calda
1519190	5 W calda

Lampadine Speciali incandescenza



6005
6006

TS40

MC22

B300

P7W - P10W
P15W - FR15
FR25 - PF15



TU3



F07

Codice	
6005	Oliva - E14 - 7,5 W
6006	Oliva - E12 - 7,5 W
P7W	Peretta - E14 - 7 W
P10W	Peretta - E14 - 10 W
P15W	Peretta - E14 - 15 W
FR15	Per Frigorifero - E14 - 15 W
FR25	Per Frigorifero - E14 - 25 W
TS40	Per Cappa - E14 - 40 W
B300	Votiva - E14 - 3 W
MC22	Macchina da cuocere - BA15D - 15 W
F07	Fiamma Oscillante - E14 - 3 W
TU3	Tubolare - E14 - 10 W
PF15	Per Forno - E14 - 15 W

LED Filamento Candela - 6W



vito

Codice	Attacco E14
1518220	Calda
1518230	Naturale
1518340	Calda dimmer

LED Filamento Candela opache - 6W



vito

Codice	Attacco E14
1518420	Calda
1518430	Naturale

LED Capsula G4 - 2,5W

Dimmerabile



vito

Codice	
92630	Calda

LED Capsula G9 - 3W

Dimmerabile



vito

Codice	
92799	Calda
92798	Naturale
92797	Fredda

LED Filamento Minisfera - 6W



vito

Codice			
1518280	E14	Calda	
1518300	E27	Calda	

LED Filamento Minisfera opache - 6W



vito

Codice			
1518440	E14	Calda	
1518450	E14	Naturale	
1518460	E27	Calda	
1518470	E27	Naturale	

LED Capsula G4 - 2 W



Codice			
1519120	Calda		
1519130	Naturale		
1519140	Fredda		

Lampadina Alogena Bastone Dimmerabili



vito

Codice	Attacco R7S
1100051	200 W - 118 mm
1100071	300 W - 118 mm
1100091	500 W - 118 mm

Lampadine colorate E27



G45

S14

G60

Codice	
1501570	G45 - Blu - 2w
1501560	G45 - Gialla - 2w
1501550	G45 - verde - 2w
1501600	S14 - Rosso - 2,5W
1501580	S14 - Bianco caldo - 2,5W
1501610	S14 - Verde - 2,5W
1501650	G60 - Rosso - 3 W
1501660	G60 - Verde - 3 W
1501670	G60 - Giallo - 3 W

Portalampade

7320040 7310020 7320080



9134



Codice



Attacco



9182

9134	GU10 - ceramica con fili 15 cm
9182	E27 - ceramica con fili 15 cm
7320040	E27 - ceramica con staffa
7310020	E27 - bachelite
7320080	MR16 - ceramica con fili 10 cm

!! Attenzione !! I prezzi del seguente volantino potrebbero cambiare più volte durante il periodo di validità.
Per essere aggiornati consultare il file Excel scaricabile dal sito Sidium.it nella sezione CATALOGHI DOWNLOAD

Fari LED Esterni neri



Codice	Colore	Watt
3022010	Naturale	10
3022020	Fredda	10
3022070	Naturale	20
3022080	Fredda	20
3022130	Naturale	30
3022140	Fredda	30
3021650	Naturale	50
3022200	Fredda	50
3021710	Naturale	100
3022230	Fredda	100
3022260	Fredda	150
3022290	Fredda	200
3022350	Fredda	400

con sensore

Codice	Colore	Watt
3022050	Fredda	10
3022110	Fredda	20
3022170	Fredda	30

Fari LED Esterni bianchi



Codice	Colore	Watt
3022430	RGB dimmerabile	20
3022440	RGB + Bi dimmerabile	50
3021715	Naturale	100

Proiettori solari a LED



3210170 - 1 W - 170 lm
Con sensore foto e PIR
Luce bianca fredda

3210190
3 W - 440 lm
Con sensore foto e PIR
Luce bianca fredda



3022480
20W - 1800 lm
bianco freddo



3210150 - 4 W - 550 lm
Con sensore foto e PIR
Luce bianca fredda

Codice
3210150
3210170
3210190
3022480

Circoline fluorescenti T9



Codice	Watt	Lumen	Colore
22021	22 W	1200 lm	Naturale
22022	22 W	1200 lm	Fredda
22032	32 W	2000 lm	Fredda
22040	40 W	2800 lm	Fredda

Pannello LED 60 x 60 - 48 W



pannello LED Venus-bc, 60x60, 48W, ultrasottile 2cm, chip Samsung

DRIVER INCLUSO

Codice	Colore
2424130	Naturale
2424140	Fredda

Dimmer 220 V con telecomando

6210070 - Dimmer 220/12V - 96W - 8A - IP20 Telecomando RF



Codice
6210070

Connettori x fotovoltaico

Coppia connettori MC4 Spina/Presca



Codice
SKU11413

Tubi LED T8 G13 Single ended

Ordine min 30 pz e multipli



vito

Codice	Lungh.	W	Lumen	Colore
1600310	60	10	1000	Naturale
1600320	60	10	1000	Fredda
1600340	120	20	1880	Naturale
1600350	120	20	1920	Freddo
1600370	150	24	2400	Naturale
1600380	150	24	2448	Freddo

Plafoniere industriali IP65

Tubi non inclusi
Clip in metallo

1 tubo 1 x G13 T8



Codice	Lungh.
3310700	60 cm
3310720	120 cm
3310740	150 cm

2 tubi 2 x G13 T8

Codice	Lungh.
3310710	60 cm
3310730	120 cm
3310750	150 cm

Sensori crepuscolari



Codice	Watt	Colore
56708	1000W - 6A	
6100020	2000W - 10A	
6100040	3000W - 25A	

Strisce LED

PREZZI A BOBINA



Codice	LED	V	W/mt	LED/mt	IP	Bobina	Colore
5540010	4040	12	14,4	60	IP20	5 mt	Calda
5540030	4040	12	14,4	60	IP20	5 mt	Fredda
5540080	4040	12	14,4	60	IP20	5 mt	RGB
212133	5050	12	6	30	IP20	5 mt	Fredda
212124	5050	12	6	30	IP20	5 mt	RGB
92553	5050	12	8	60	IP20	5 mt	RGB
212553	5050	12	8	60	IP20	5 mt	RGB+Ca
212159	5050	12	8	60	IP20	5 mt	RGB+Fr
92552	5050	12	10,8	60	IP20	5 mt	Calda
92551	5050	12	10,8	60	IP20	5 mt	Naturale
92550	5050	12	10,8	60	IP20	5 mt	Fredda
10305	5050	12	10,8	60	IP65	5 mt	Calda
10306	5050	12	10,8	60	IP65	5 mt	Naturale
10304	5050	12	10,8	60	IP65	5 mt	Fredda
212430	5050	24	10	60	IP20	5 mt	Fredda
2624	2835	24	7,2	120	IP20	10 mt	Fredda
212597	2835	24	12	168	IP20	5 mt	Naturale
212596	2835	24	12	168	IP20	5 mt	Calda
212016	3528	12	4,2	60	IP20	5 mt	Calda
212041	3528	12	4,2	60	IP20	5 mt	Naturale
212005	3528	12	4,2	60	IP20	5 mt	Fredda
212025	3528	12	8	120	IP20	5 mt	Calda
212042	3528	12	8	120	IP20	5 mt	Naturale
212002	3528	12	8	120	IP20	5 mt	Fredda

!! Attenzione !! I prezzi del seguente volantino potrebbero cambiare più volte durante il periodo di validità.

Per essere aggiornati consultare il file Excel scaricabile dal sito Sidium.it nella sezione CATALOGHI DOWNLOAD

Lampada di Emergenza



899 - da incasso - 3,8 W
Chip Samsung -
Luce fredda -
Autonomia 5 h

5020090 - 2 W - Luce fredda - Autonomia 3 h



Codice

899

5020090

Torçe / Lanterne Ricaricabili



5000410

Torcia 3 W

Lanterna 19 W



5000450

Torcia 2 W



5000490

Torcia 1 W



5000480

Torcia 2 W

Lanterna 1 W



5000470

Torcia 5 W

Lanterna 2 W



5000370

Torcia 0,5 W

Lanterna 6 W



5000430

Torcia 3 W



5000520

Torcia 3 W



5000510

Torcia 3 W



5000500

Torcia 3 W

Codice

5000450

5000430

5000410

5000370

5000470

5000480

5000490

5000500

5000510

5000520

Plafoniere 40 W



58 x 82 x 1200 mm
4300 lumen
corpo in alluminio

Codice	Corpo	Colore
2429780	Bianco	Caldo
2429790	Bianco	Naturale
2429810	Nero	Caldo
2429820	Nero	Naturale

Sensore di movimento



S95174



6110080

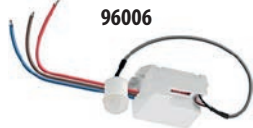

96006

Codice

S95174 Bianco

96006 da incasso

6110080 da soffitto

Sottopensili



SOTTOPENSILI SLIM

Largh x Altezz : 73 x 23 mm
Lumen : 18W : 1332 - 36W : 2664



SOTTOPENSILI CON INTERRUETTORE

Largh x Altezz : 22 x 35 mm
Lumen : 4W : 408 - 8W : 816
12W : 1080 - 16W : 1530

SOTTOPENSILI SLIM

Codice Watt Colore Lungh mm

2310410 18 Naturale 580

2310440 36 Naturale 1180

SOTTOPENSILI CON INTERRUETTORE

Codice Watt Colore Lungh mm

2313230 4 Naturale 311

2313250 8 Naturale 572

2313260 8 Fredda 572

2313270 12 Naturale 872

2313290 16 Naturale 1172

Plafoniere ultrapiatte



Luce bianca naturale
angolo 120°

Codice

2027120 18 W - Ø 220 x 40 - 2160 lm

2027130 24 W - Ø 290 x 42 - 2880 lm

2027140 36 W - Ø 350 x 43 - 4320 - lm

2027150 50 W - Ø 450 x 48 - 6000 lm

Punti luce



6018B - Luce arma-
dio con sensore e
schermo inclinabile



96501 - Lampada
da notte con sensore
movimento



64567 - con presa elettrica passante
(Schuko) con cambio colore (verde,
blu, luce diurna), sensore crepu-
scolare



5200420 - Lampada da notte -
Luce fredda - luce continua



5200570
- Lampada
da notte -
RGB - Luce
continua

Codice

6018B

5200420

96501

5200570

64567

Plafoniere con sensore



2022660 senza lampadine -
attacchi 2 x E27 - Ø 295 x 95
mm - Vetro e acciaio

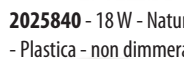

2025840 - 18 W - Naturale - Ø 295 x 70 mm
- Plastica - non dimmerabile

vito



Codice

2022660

2025840

Lampade da tavolo



10190 - 10194 - 10187

10191 - 10188 3W in metallo

Ricaricabili USB-C - Touch - Dim-

merabili



INN-291B - INN-291W

1W in metallo - Ricaricabili

USB-C - Touch - Dimmerabili



INN-291B - INN-291W 2,5W
in metallo - Ricaricabili USB-C -
Touch - Dimmerabili

Codice Colore Luce

10190 Rame Naturale

10194 Nero Naturale

10187 Grigio Calda

10191 Bianco Calda

10188 Grigio Naturale

5301600 Bianco Bi-Na-Fr

5301610 Verde Bi-Na-Fr

INN-293B Nero Bi-Na-Fr

INN-293W Bianco Bi-Na-Fr

INN-291B Nero Bi-Na-Fr

INN-291W Bianco Bi-Na-Fr

INN-290B Nero

INN-290W Bianco



5301600 - 5301600

6W Ricaricabile - Dimme-

rabile - 3 tonalità di luce



INN-290B - INN-290W Lampade LED per
bottiglie 2,5W - Ricaricabili USB-C - Touch -
Dimmerabili

!! Attenzione !! I prezzi del seguente volantino potrebbero cambiare più volte durante il periodo di validità.

Per essere aggiornati consultare il file Excel scaricabile dal sito Sidium.it nella sezione CATALOGHI DOWNLOAD

Kit NVR 8 Canali PoE + 4 Telecamere dome 4 MPX



Kit completo di videosorveglianza composto da:
1 NVR a 8 canali 4 Mpx, 4 telecamere CCD 4 Mpx

Videoregistratore NVR a 8 canali,
• Supporta un Hard Disk Sata max 8 TB (1TB incluso) • Supporta telecamere analogiche HD, CVI, TVI, AHD, IP • 3 funzioni di registrazione • Uscita di USB per salvataggio registrazioni

Codice
455051

Telecamera con Pannello Solare 4G



Sensore di Movimento con Mic e Altoparlante

Connessione con SIM 4G

Codice
161046

Fototrappole

TX189 - con SIM 4G (Nano SIM) e pannello solare, Risoluzione video FullHD 2560x1440
- Rilevamento del movimento - visione notturna



TX69 - Risoluzione video FullHD 1080p
- Display LCD TFT da 2,4" - Microfono e altoparlante integrati - Scheda MicroSD** fino a 32GB (**non inclusa)



WCAM130GN - 1080p@30fps | 16.0 MPixel | IP66 | Visione notturna | Sensore di movimento
Dimensione dello schermo: **WCAM130GN**
TX69
TX189

Kit Wi-Fi NVR + 4 telecamere 3 Mpx



Kit completo di videosorveglianza composto da:
1 DVR a 4 canali 5 Mpx, 4 telecamere CCD 5 Mpx, 4 cavi di collegamento

Consente la visione, la registrazione su hard-disk fino a 4 TB (HDD incluso da 1 TB) e la messa in rete di immagini provenienti da telecamere IP wireless (fino a 4 incluse) • Funzioni di registrazione: manuale, rilevazione di movimento, programmazione oraria settimanale • Possibilità di visualizzarlo da remoto e da smartphone tramite tecnologia cloud, semplificando al massimo il settaggio delle impostazioni • Uscita di USB per salvataggio registrazioni

Codice
455020

Spioncino digitale Wi-Fi 4,3"



Funziona con App TUYA su dispositivi iOS e Android. Registrazione su scheda SD. Rilevazione movimento su App

Codice
365050

Telecamera pin hole HD



Lente: Fissa
Focale: 3,7 mm
Grado di protezione: IP55
Alluminio pressofuso bianco

Codice	MPx	Risol.	Focale	Led
122013	1,3	2K	3,7	-

Kit Sistema Anti Intrusione GSM Panther 36

ASSISTENZA TECNICA DIRETTA DEL PRODUTTORE



Il Kit è composto da: n.1 Centrale in box metallico apertura a libro e vano batterie con integrati ricevente radio e sirena interna, caricabatterie, tastiera integrata e GSM- 4 zone filari + 36 radioprogrammabili - n.2 Radiocomandi MVG-1109/4P o 10311- n.1 Contatto Magnetico via radio MVS-1109/PC - n.1 Sensore volumetrico PIR via radio MVS-1109/ANT

MICROVIDEO Codice
56494

Sirena per esterno autoalimentata



12Vdc • Lampeggiante LED • Indicazione stato impianto • Calotta policarbonato • Struttura ABS • Tamper antiapertura / antistrappo • Bolla di centratura

Codice
71735

Sensori filari **MICROVIDEO**



56718 - Rilevatore volumetrico di movimento a filo. Doppia tecnologia a tenda da esterno. Portata 12 mt. Angolo 110°



58859 - Contatto magnetico a filo per infissi. In plastica - 14 x 28 x 6 mm.



SR925 - Contatto magnetico da esterno con terminali a vite

Codice
56718
58859
SR925

Misuratore digitale pressione



Da polso.
Grande display LCD

Codice
INN-008

Piastra elettrica doppia



2000 W

Codice
INN-748

Ferro da stiro a vapore



1800 W - Controllo temperatura
Vapore regolabile

Codice
INN-678

Bollitore cordless



1,8 lt - 1800 Watt
filtro anti-calcare - con spegnimento automatico

Codice
INN-732

Phon da viaggio



1200 W

Codice
INN-614

Fornello a gas 2 fuochi



Codice
A00004

Frullatore ad immersione



Lame in acciaio
250 Watt

Codice
INN-705

Aspirapolvere wireless



90 W -
senza sacchetto -
ultraleggero

Codice
INN-659ULTRA

Bilancia da cucina



Capacità: 5 Kg.
• Divisione: 1 g.
• Unità di misura:
g/lb/oz/fl/oz/ml/kg

Codice
INN-133Y

Set tagliacapelli / barba



Lame di precisione
in acciaio inossidabile
Guide di taglio
fino a 1,2mm

Codice
INN-616

Tostapane



2 scomparti
2 pinze per toast farciti
6 livelli di doratura
Alimentazione: 240 V,
Potenza: 650/750W

Codice
INN-742

Bilancia pesapersone



Capacità: 180kg
Divisione: 100g
Pedana in vetro temperato

Codice
INN-142G